

MINGDA

MD-600D

Print Bigger ⚡ Faster



Eight Advantages



5X Faster
Print Speed



600*600*600mm
Large Build Volume



Dual Extruder



350 degrees High
Temperature Hot End



New Cooling
System Design



Camera & WIFI



Free Leveling



Input Shaper

Fighter jets in industrial large Format 3D printers with **Dual Nozzles**



**Direct Drive
Dual Extrusion System**



Support materials
can be printed



Print two colors
simultaneously



Maximum heating temperature **350°C**

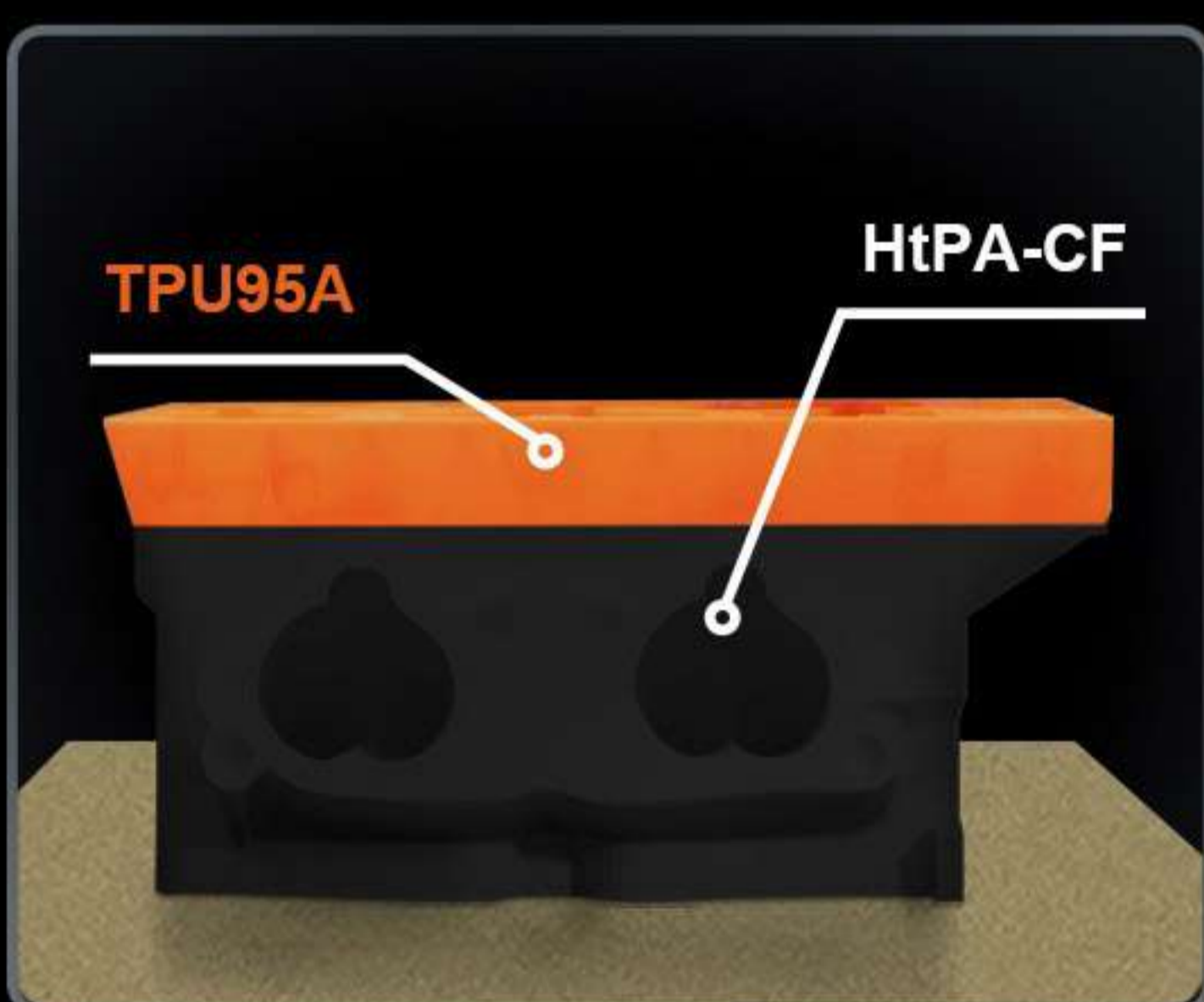

Supports **TPU95A** and **HtPA-CF**,
while printing **TPU** and **PETG** simultaneously.



Supports **water-soluble filament** printing

5X Speed, Breakthrough in Printing Efficiency Once Again

MD-600D printing speed up to 300mm/s, 10000mm/s² Peak acceleration, only 0.02s speed up form 0 to 300mm/s, achieving ultra-high efficiency printing.

500mm/s

Travel speed

300mm/s

High-Speed

40mm³/s

Max Flow

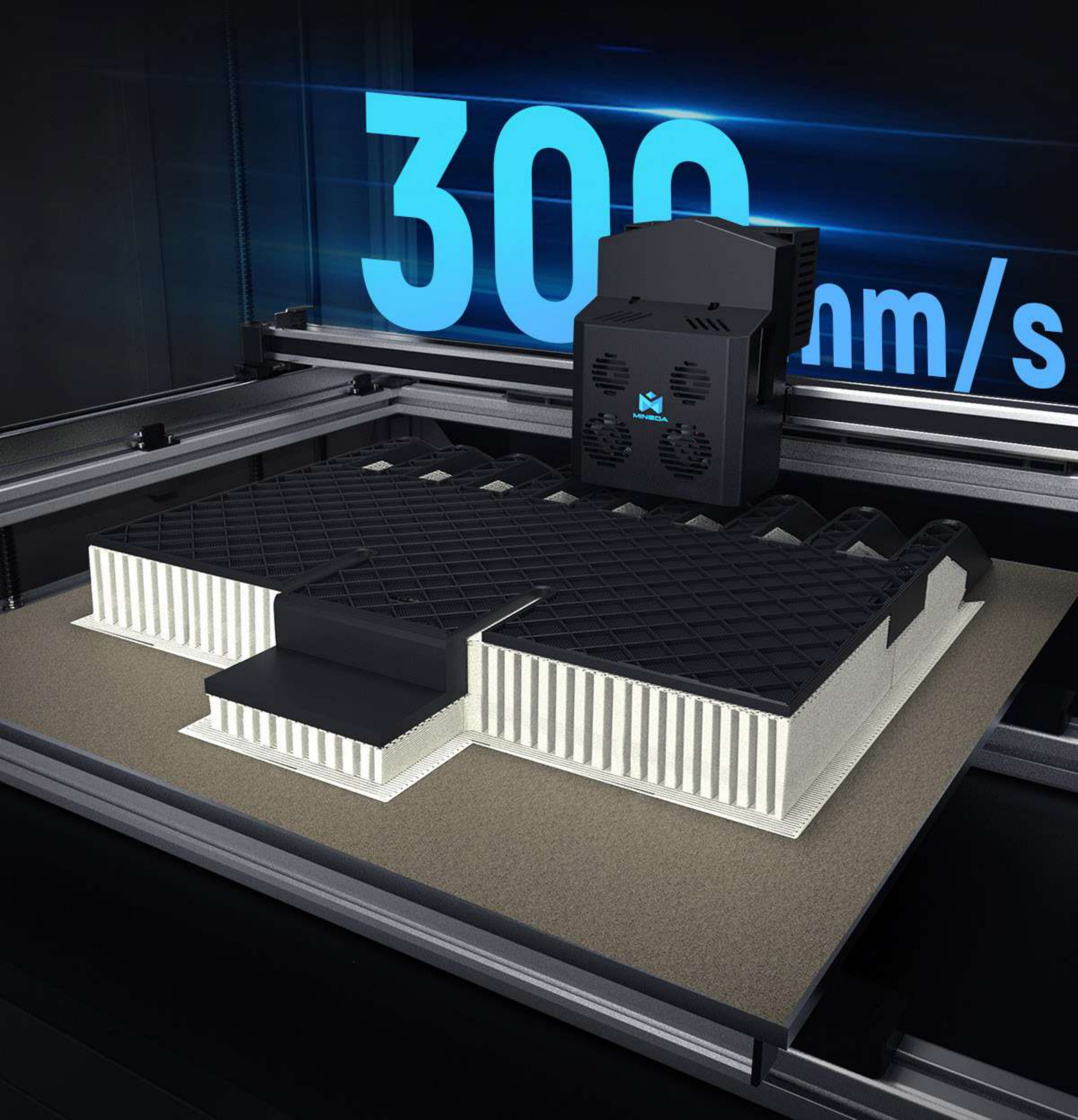

High Speed, Starting From Slicing

MINGDA Slicer, a new generation of self-developed slicing software, is easy to use, has rich presets, and is deeply optimized for high-speed printing.

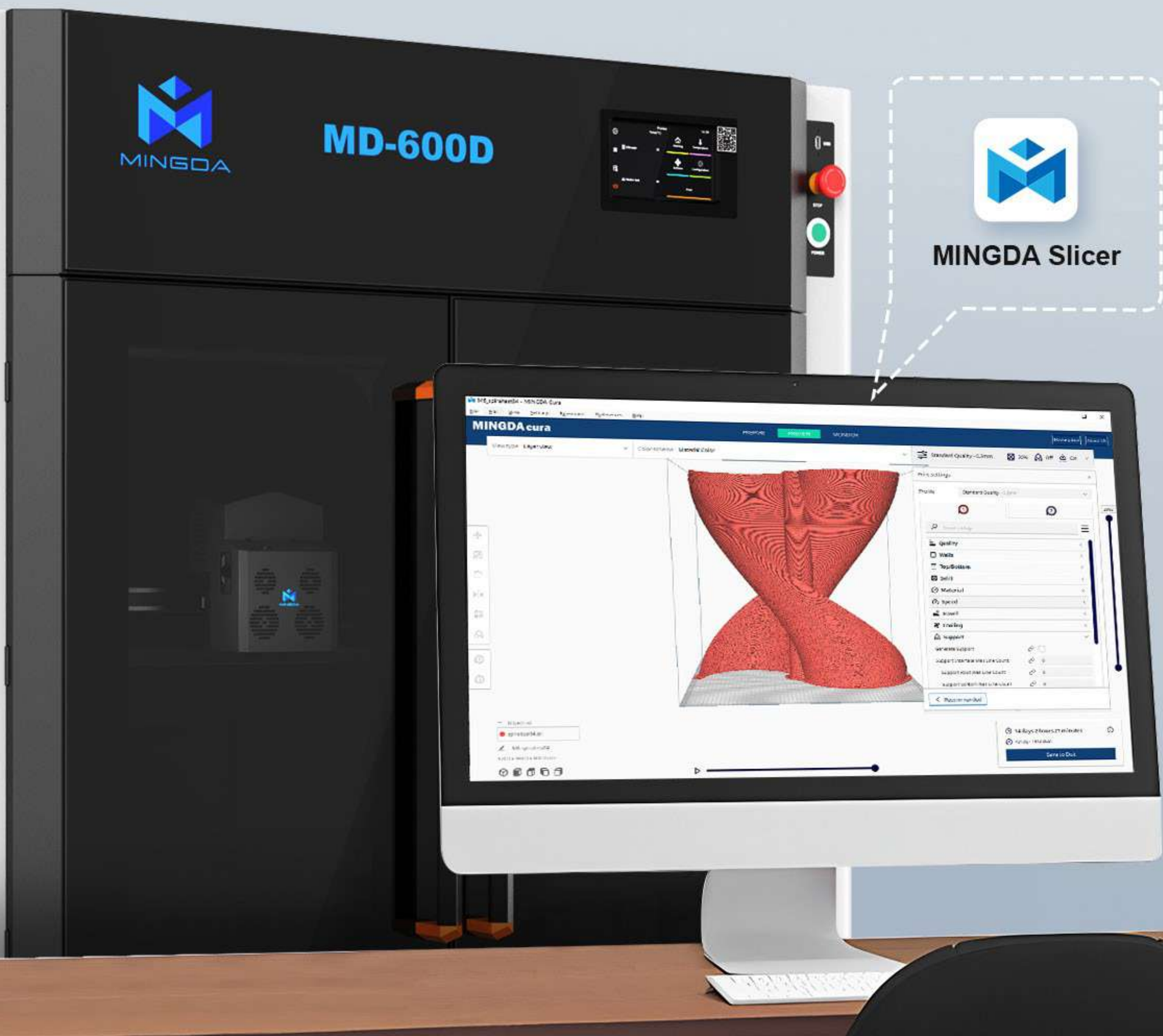

Wind Turbine Case Sharing



Filament

PLA-HF

Speed

250mm/s

Model size

600*500*600mm

Printing time

24 hours

Compare other regular FDM large format printers on the market

Filament: **Ordinary PLA**

Printing Speed: **50mm/s**

Printing Time: **5 days**

* The experimental data is for reference only

Large Printing Size

Large Printing Size: 600*600*600mm

Machine size: 1300*965*1255mm

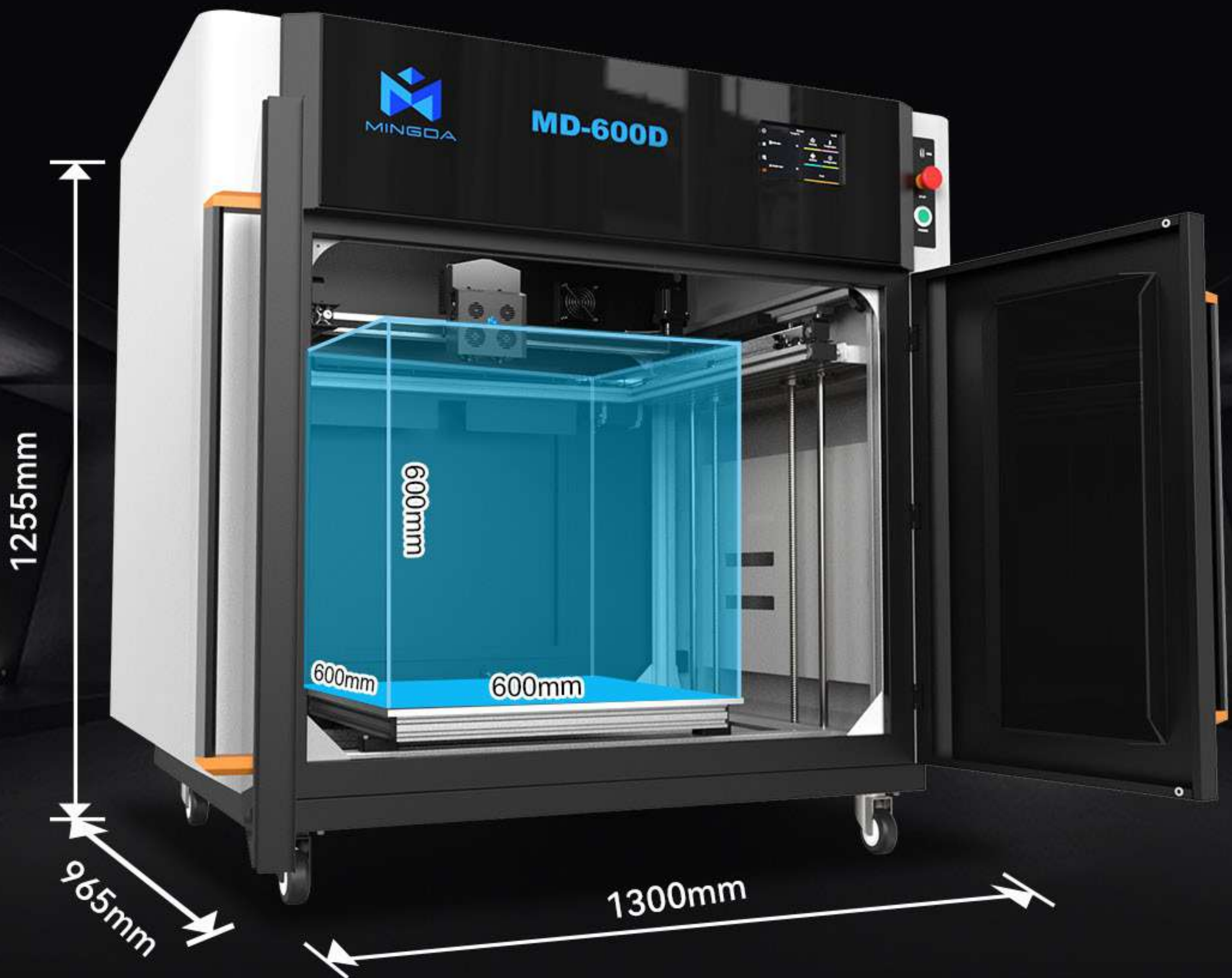

We Provide The Following Promises

Good after-sales service is the key to test whether a company manufactures high-quality products



One Year
Warranty



Lifetime
Maintenance



Factory
Direct Sales



Quality
Assurance



Technical
Support

Remote Printing Multi-Machine Control

After being connected via WiFi or network cable, the MD-600D can be remotely printed and monitored in real time. At the same time, it also supports multi machine control, facilitating rapid mass production.



Hands-free **Auto Leveling**

Making preparation before printing more convenient, Accurate first layer detection.

10*10 Points
Auto Leveling

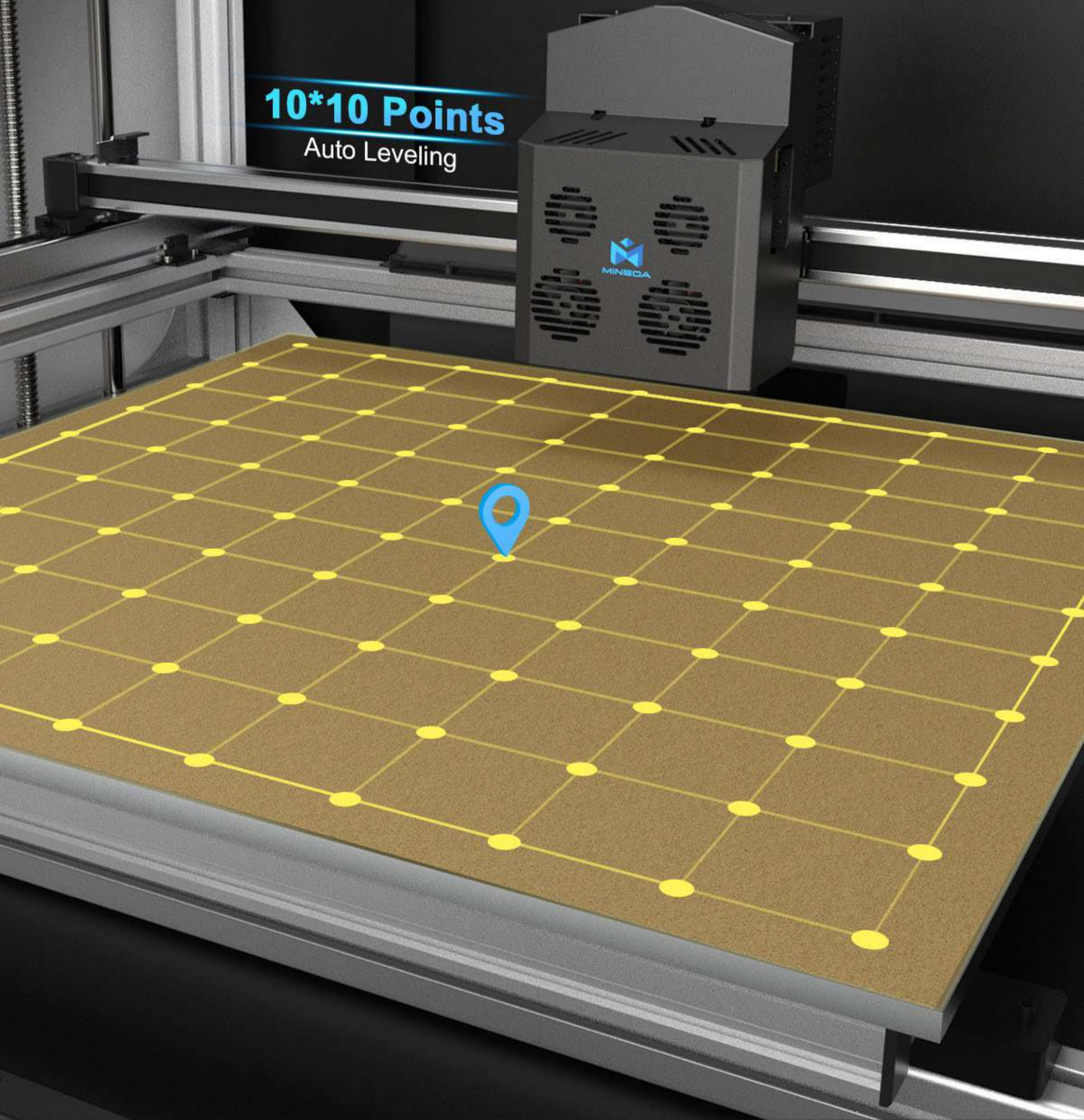

± 0.1mm High Precision

Using modular guide rail structure and closed-loop motor design to ensure the stability and accuracy of the printing process

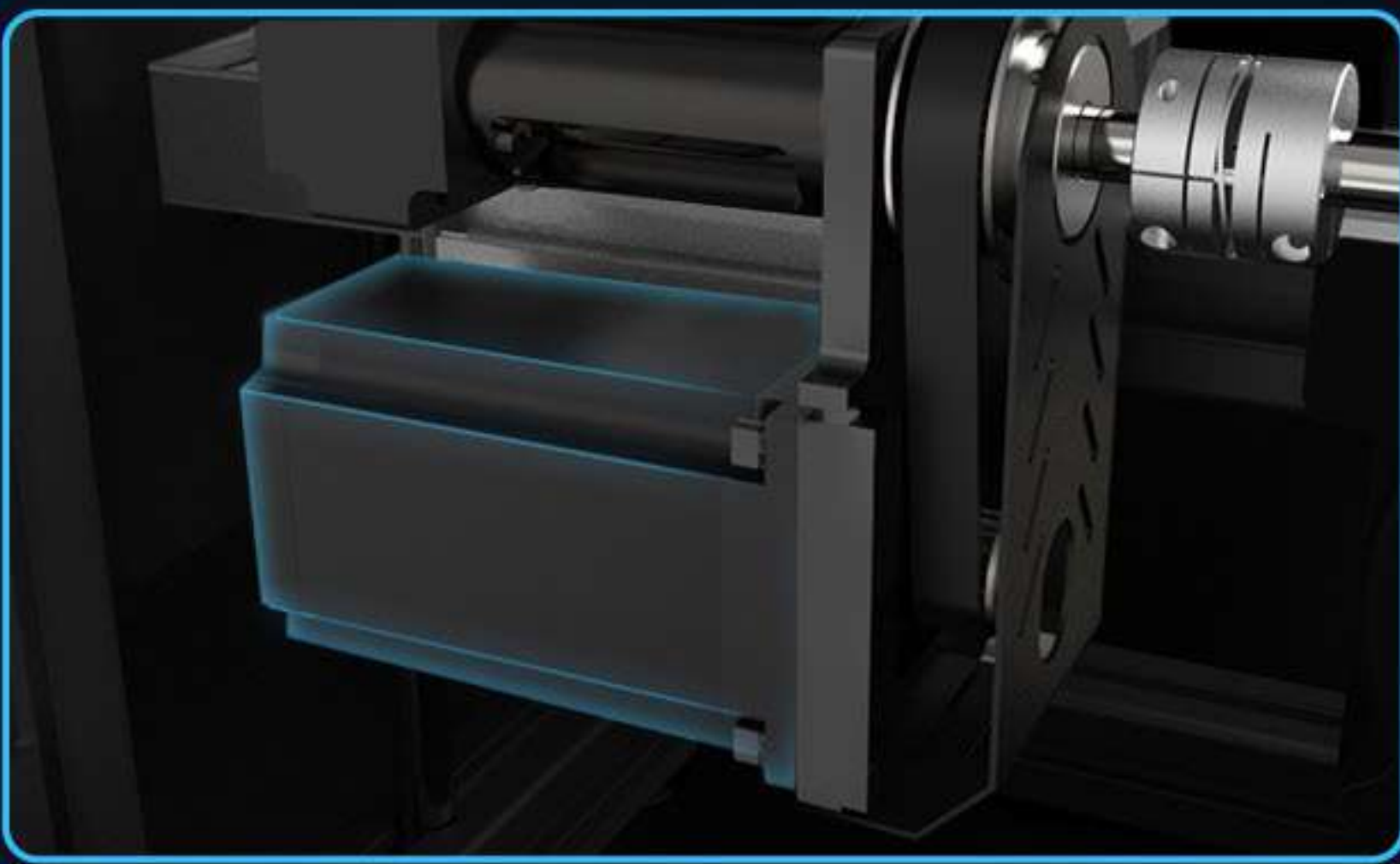
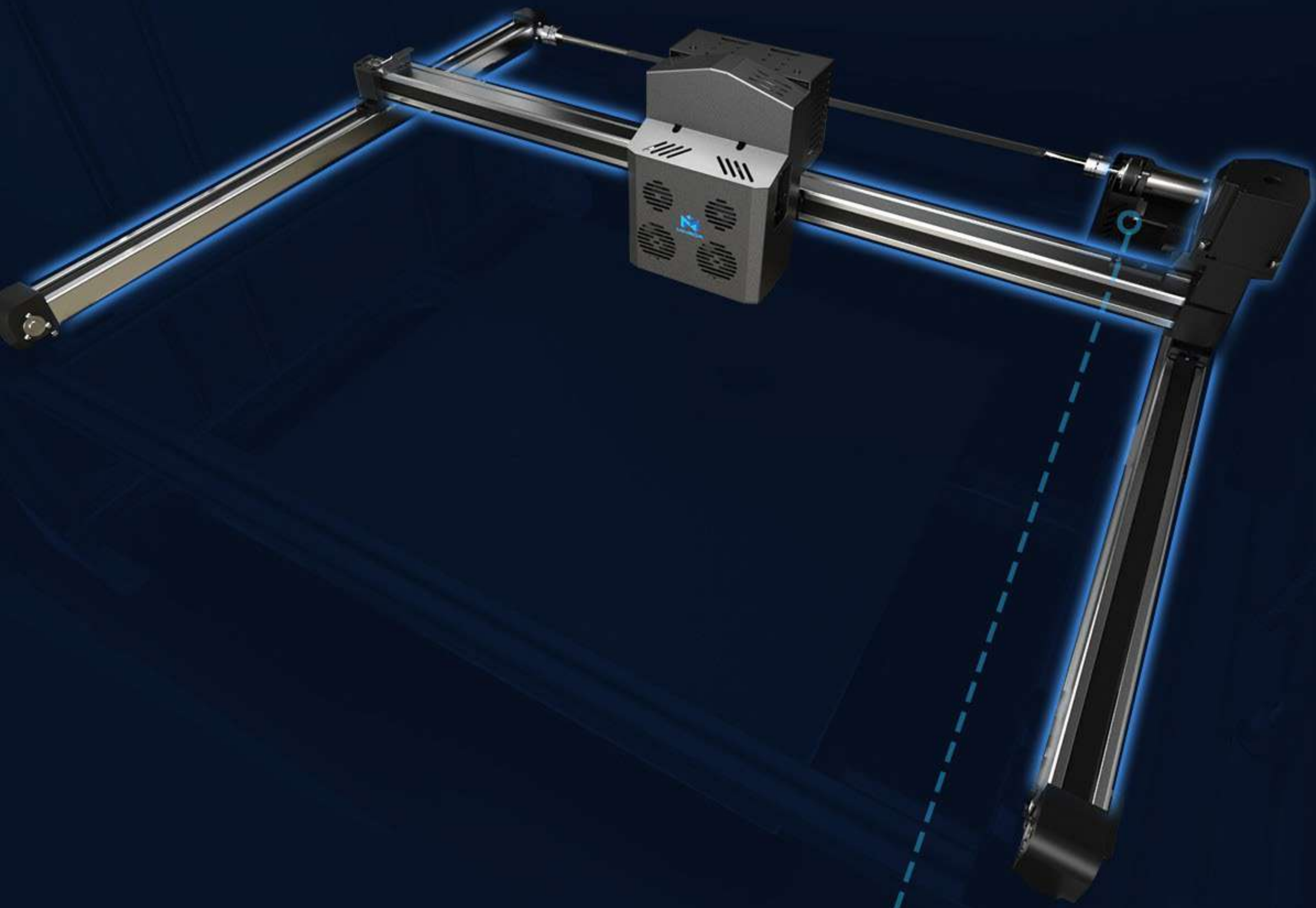

Closed-loop stepper motors

The MD-600D is equipped with closed-loop stepper motors. Compared to traditional open-loop stepper motors, it has powerful feedback capabilities, faster speeds, higher precision, and lower heat generation.

Excellent in Detail



Input Shaper

Reduce vibration patterns and make the surface smoother

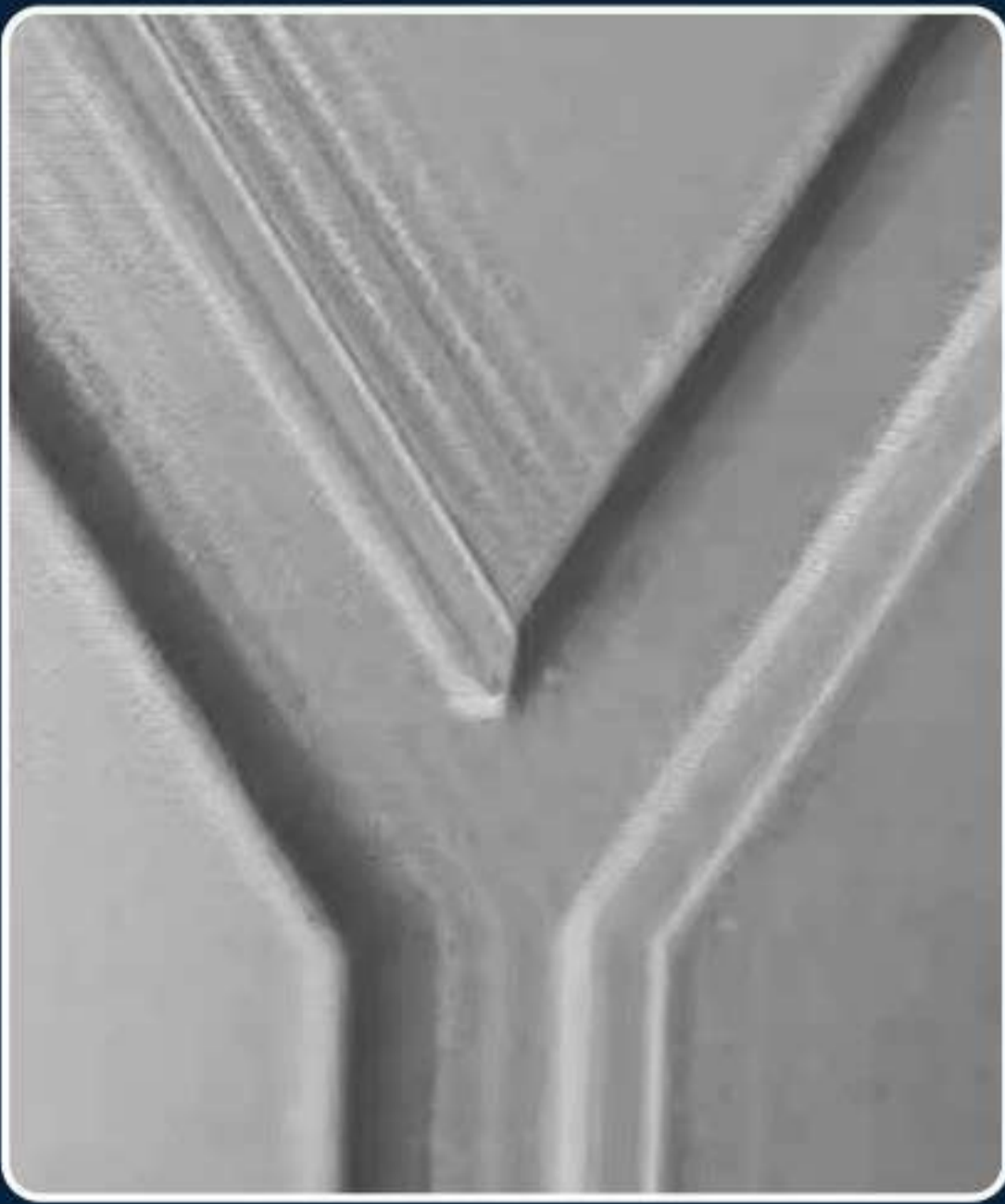

OFF

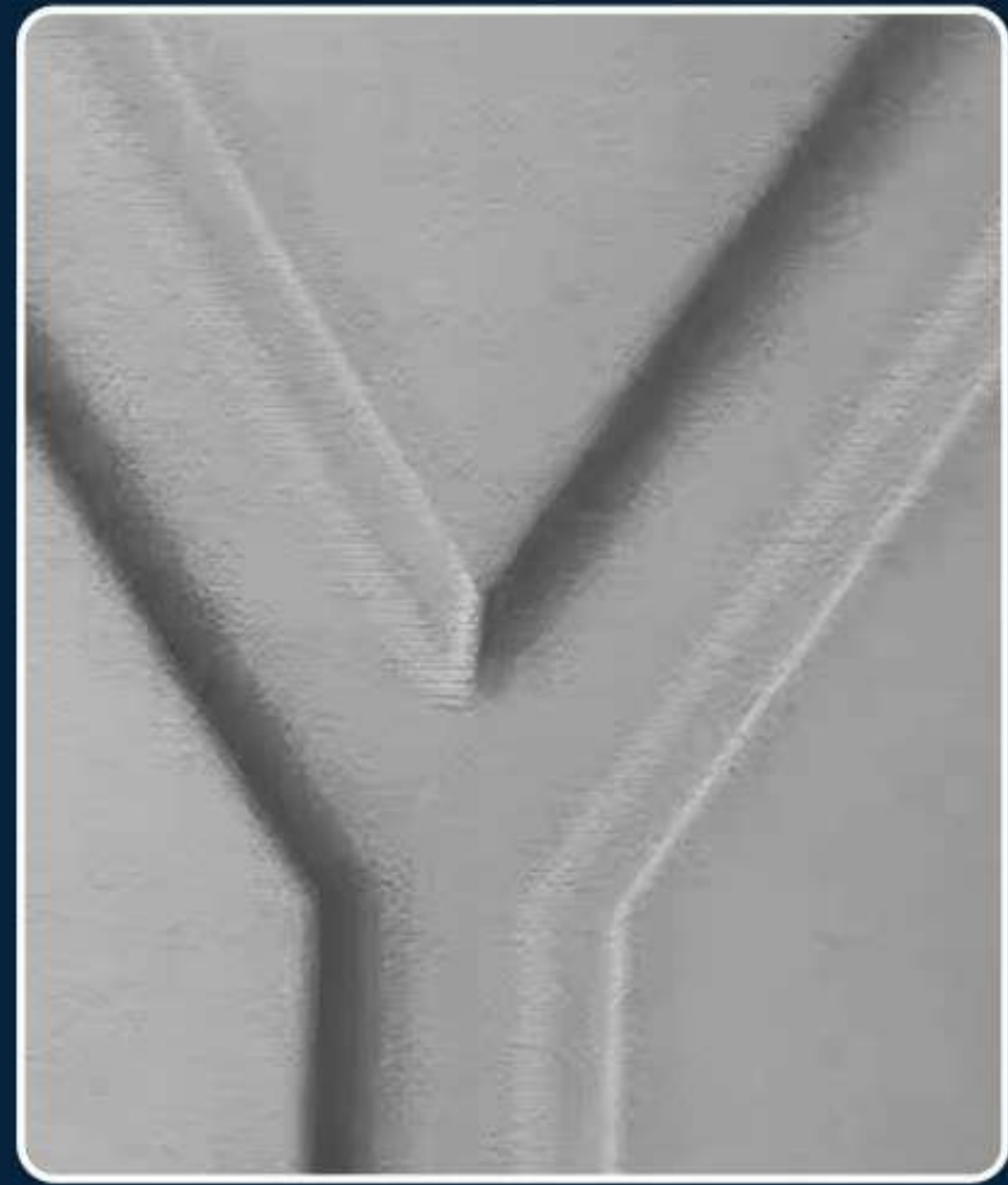

ON

Flow Control

Improved print quality and accuracy. Flow control allows precise management of the amount of filament being extruded, reducing errors like under/over-extrusion. This leads to smoother prints with sharper details.



OFF

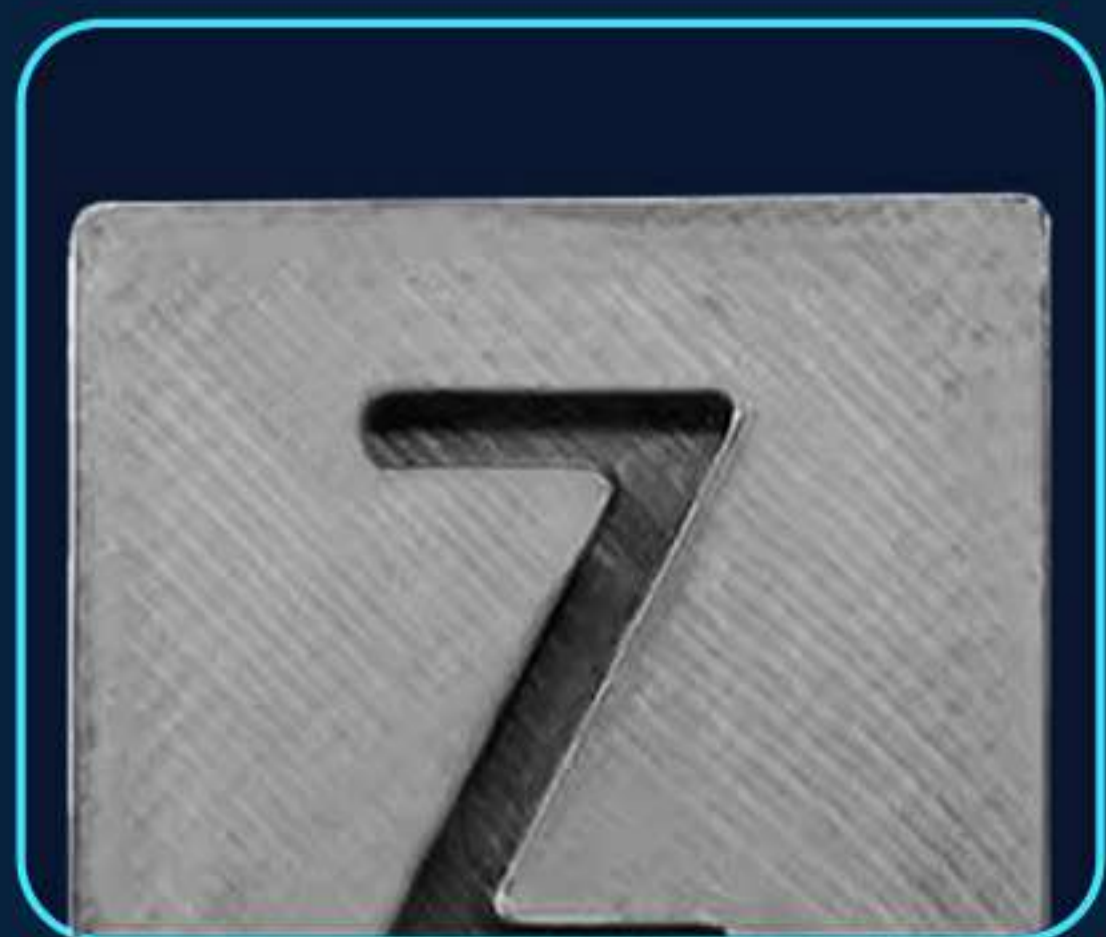

ON

New Cooling System Design

The dual cooling system truly takes model cooling to the next level with an aerodynamic air duct design that blasts models with intensely powerful directed airflow for enhanced cooling capabilities, crafting perfect prints.



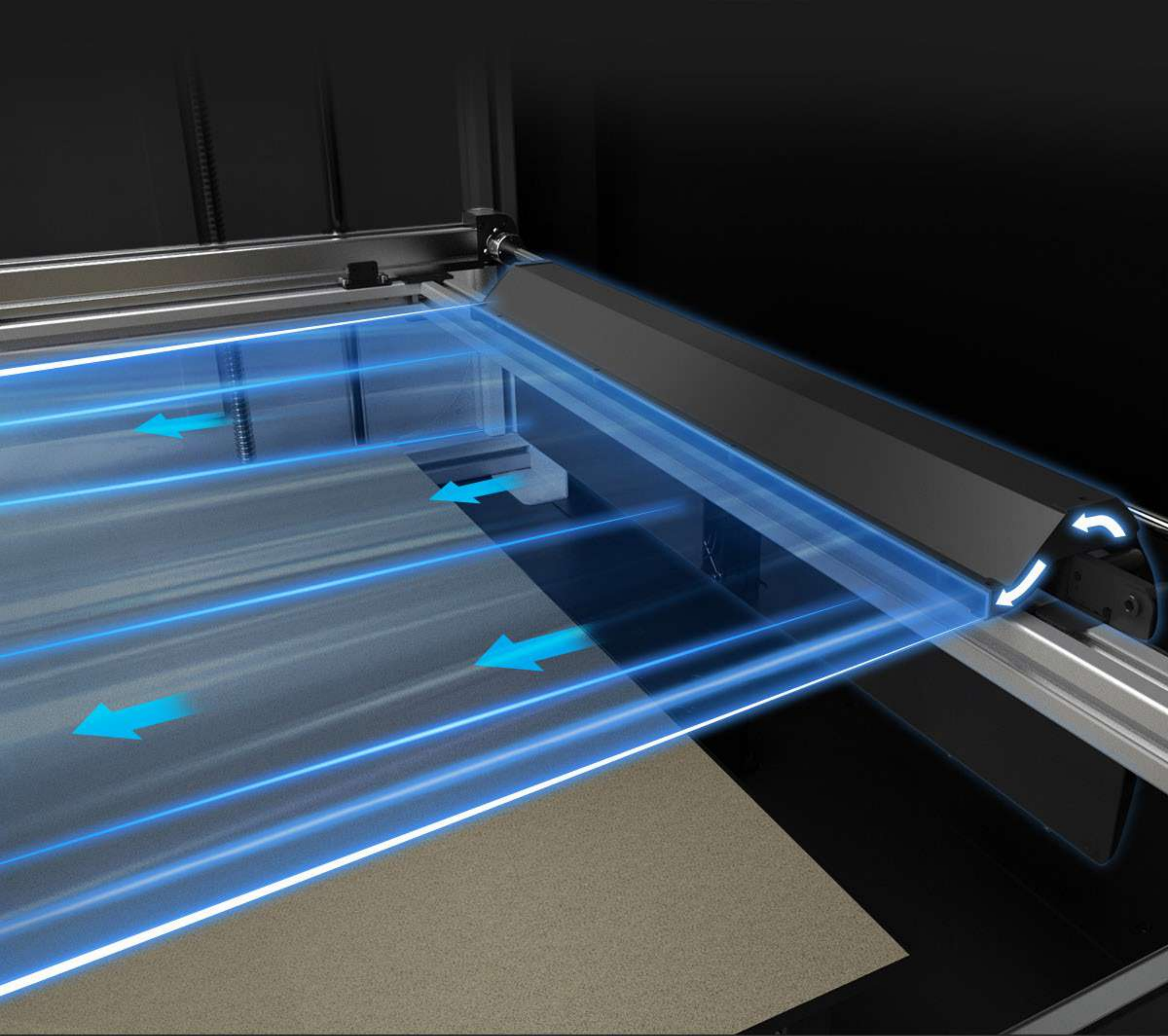

Speed cool solidification, effectively avoid stringing, warping

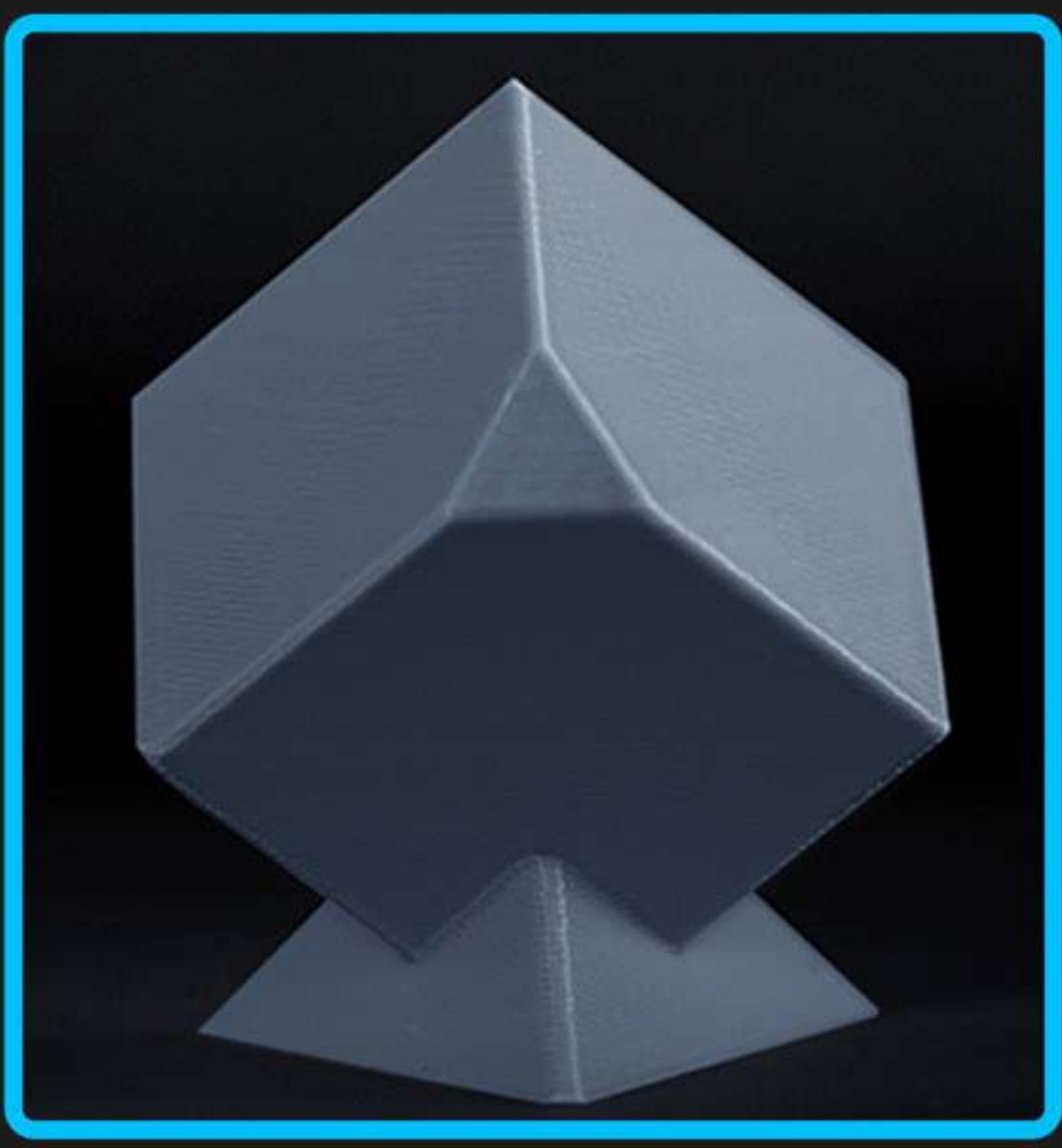

Mingda air cooling effect

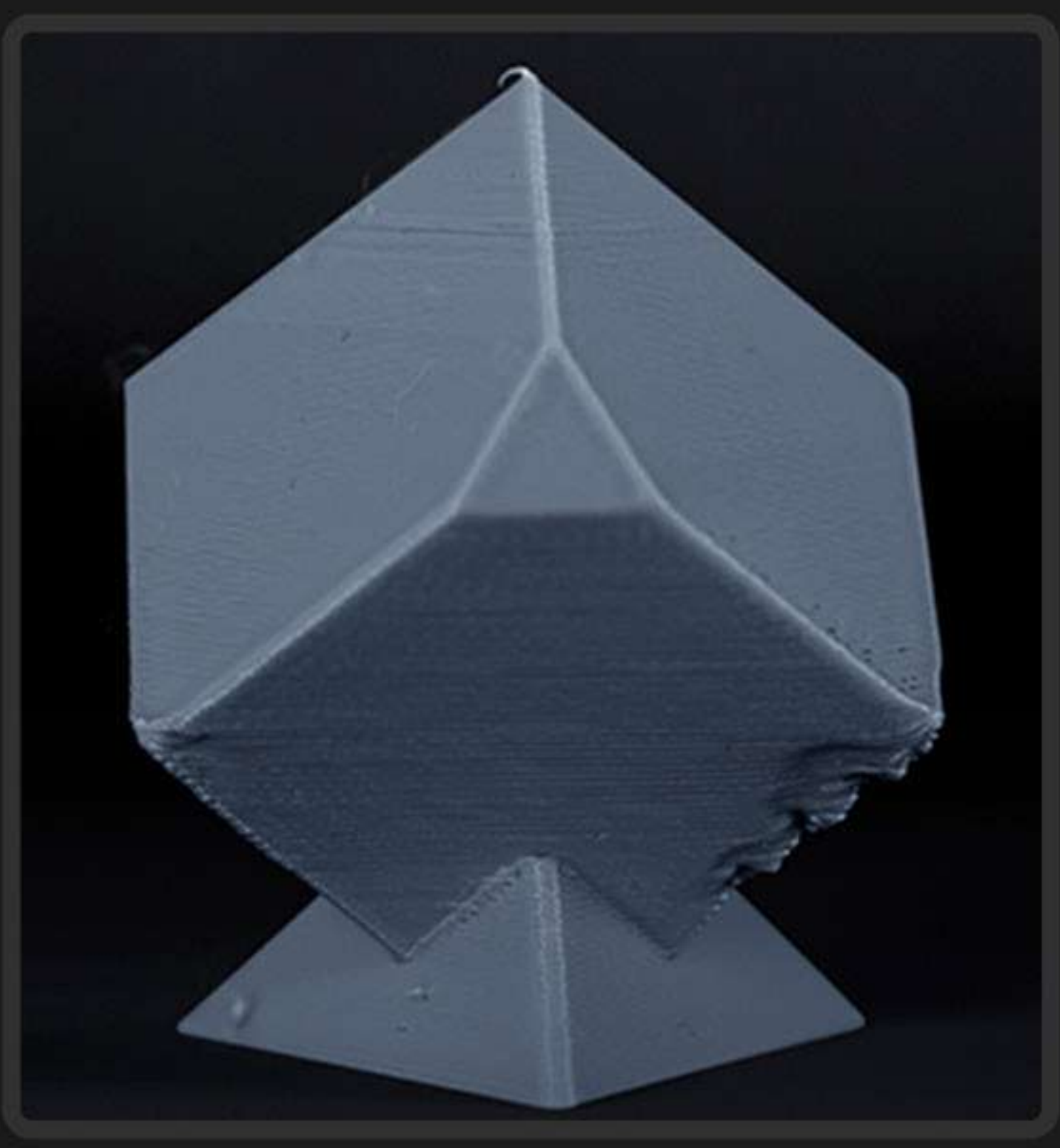

Regular air cooling effect

PEI Flexible Printing Platform

It has strong adhesion, high temperature resistance, and is suitable for various consumables. It can be easily removed by bending.

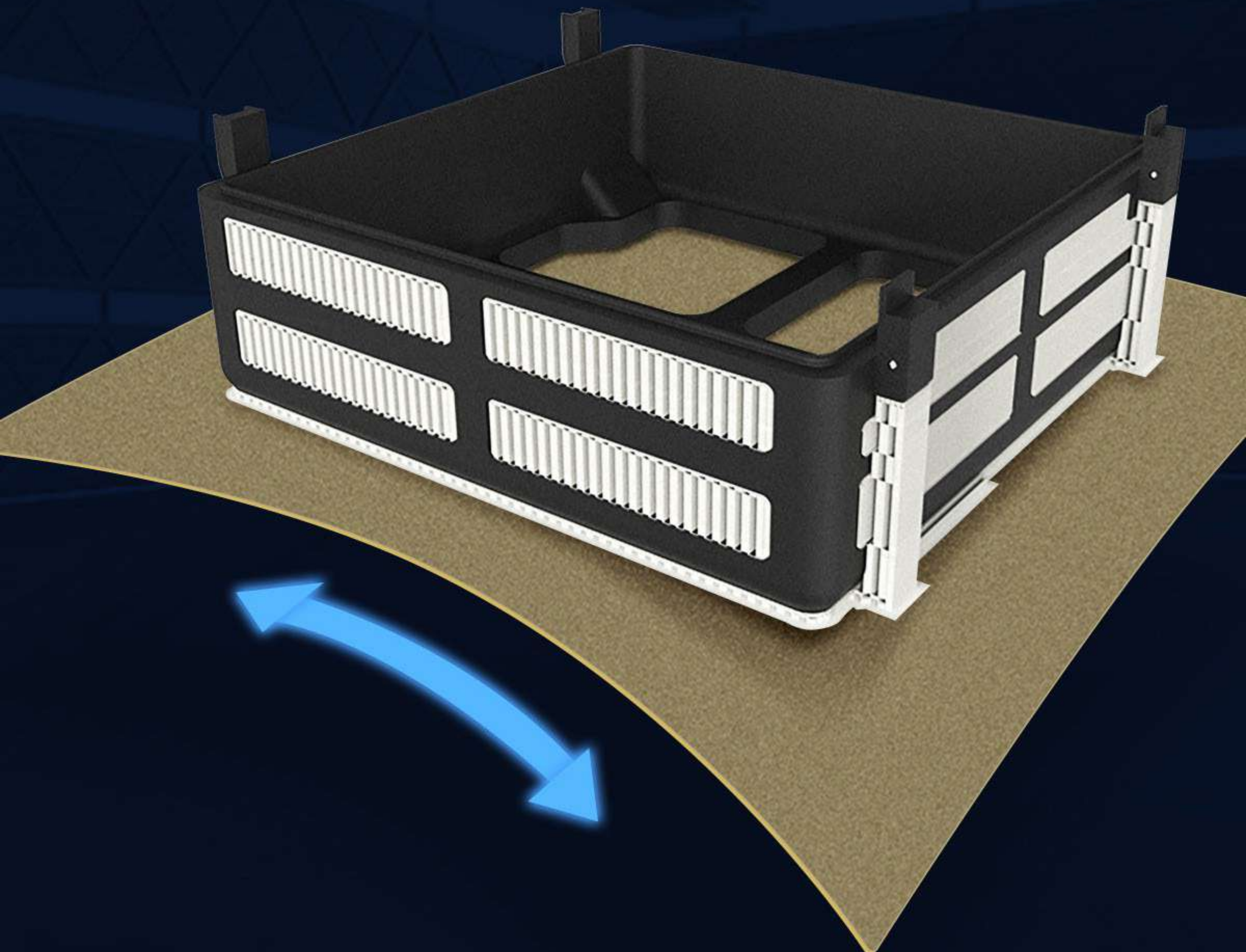

Quick Heating Bed

Max temperature of heating bed is 110°C. Aluminum alloy hot bed, evenly heated, can be heated to 60 degrees Celsius in about 75 seconds; The heating speed remains unchanged at 220V and 110V voltages.

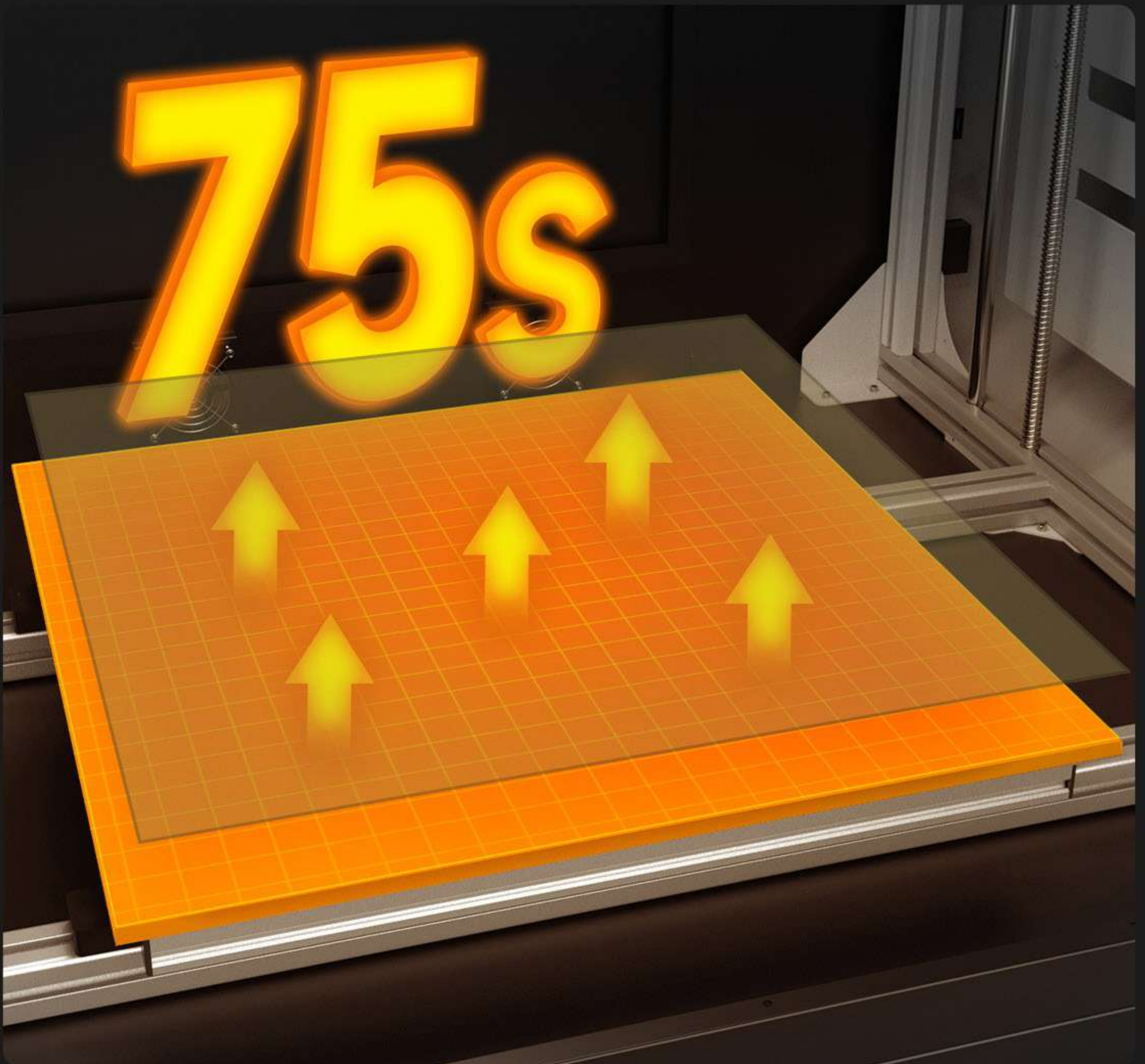

MINGDA Self-developed Core Hardware Delivers Speedy Smooth Performance.

This high-performance **64-bit self-developed motherboard**, powered by the 6-core CPU, ensures fast processing of data and rapid completion of 3D printing tasks. With **32GB of memory**, you can quickly store, export, and print large files with ease.



7-inch IPS

High-definition Large Screen

MD-600D has a 7-inch IPS 2.1 million high-definition computer screen. Compared with traditional LCD screens, it can see bright, saturated, and natural high-quality images from any angle. At the same time, it is more environmentally friendly and saves electricity.



Support multiple languages

1. English
2. Danish
3. German
4. Spanish
5. French
6. Hebrew
7. Hungarian
8. Italian
9. Japanese
10. Korean
11. Poland
12. Portugal
13. Russia
14. Sweden
15. Turkey
16. Ukraine
17. Chinese
18. Dutch
19. Czech
- etc

Self Check when Power on

When power on it can automatically check the status of the extruder, hot bed, camera, automatic leveling, fan, and other components; If there are any abnormalities, a prompt will be displayed on the printer screen for quick and convenient processing.





Smart Resume Printing Function

The machine can automatically resume printing after power offer, less worries on print failure.

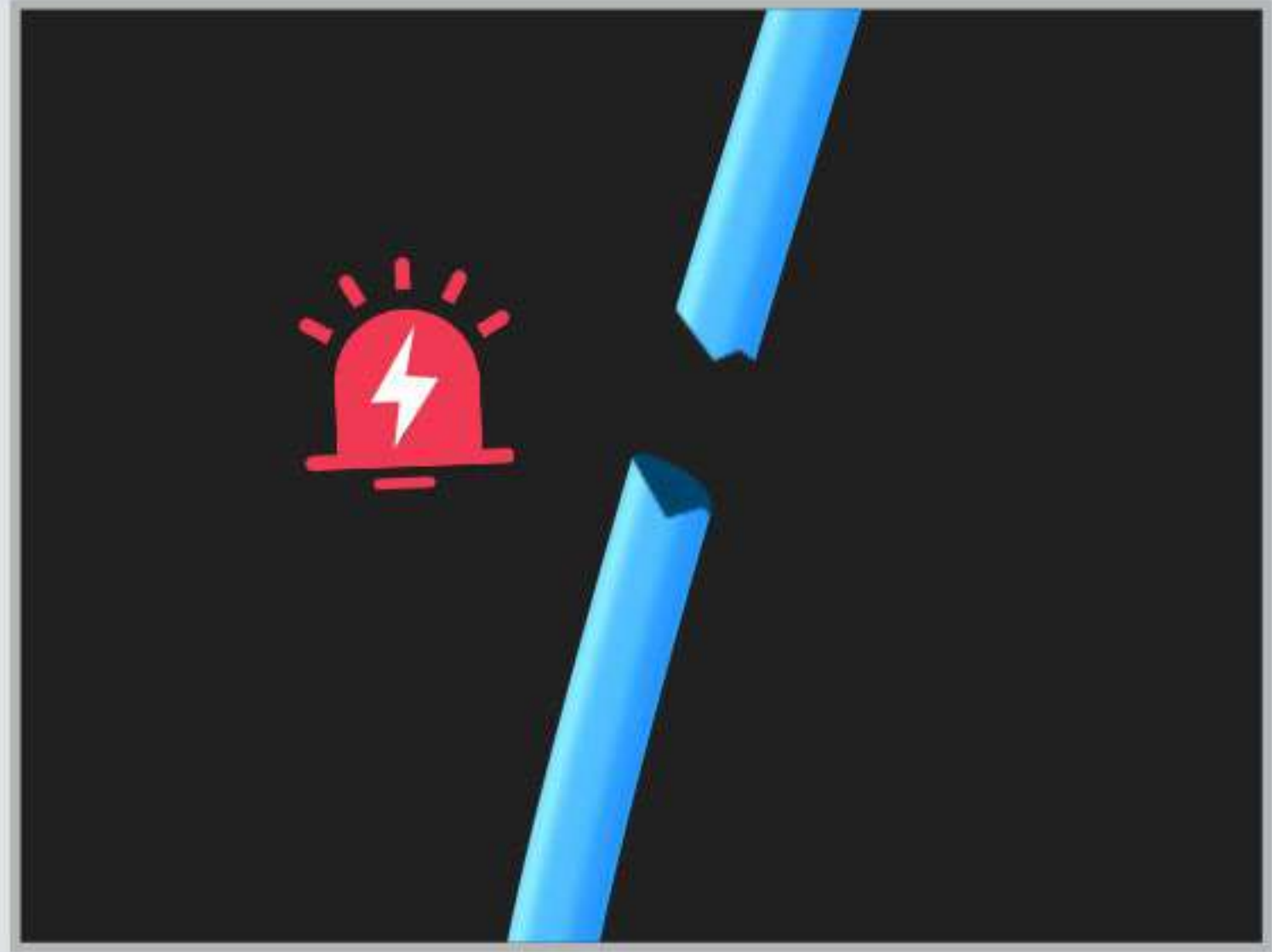

Automatic Filament Detection

It will pause the printing process, if the filament run out or if the filament is broken.

Compatible With Various Filaments

Common filament

PLA, TPU, PETG, etc

Support filament

S-Multit, S-HtPA, PVA, etc

Engineering filament

HtPA, PET-GF, PET-CF, PA12-CF, HTPA-GF, HTPA-CF,
ABS-GF25, ABS-CF20, PA-GF25, PA-CF25, etc



Applicable Industries

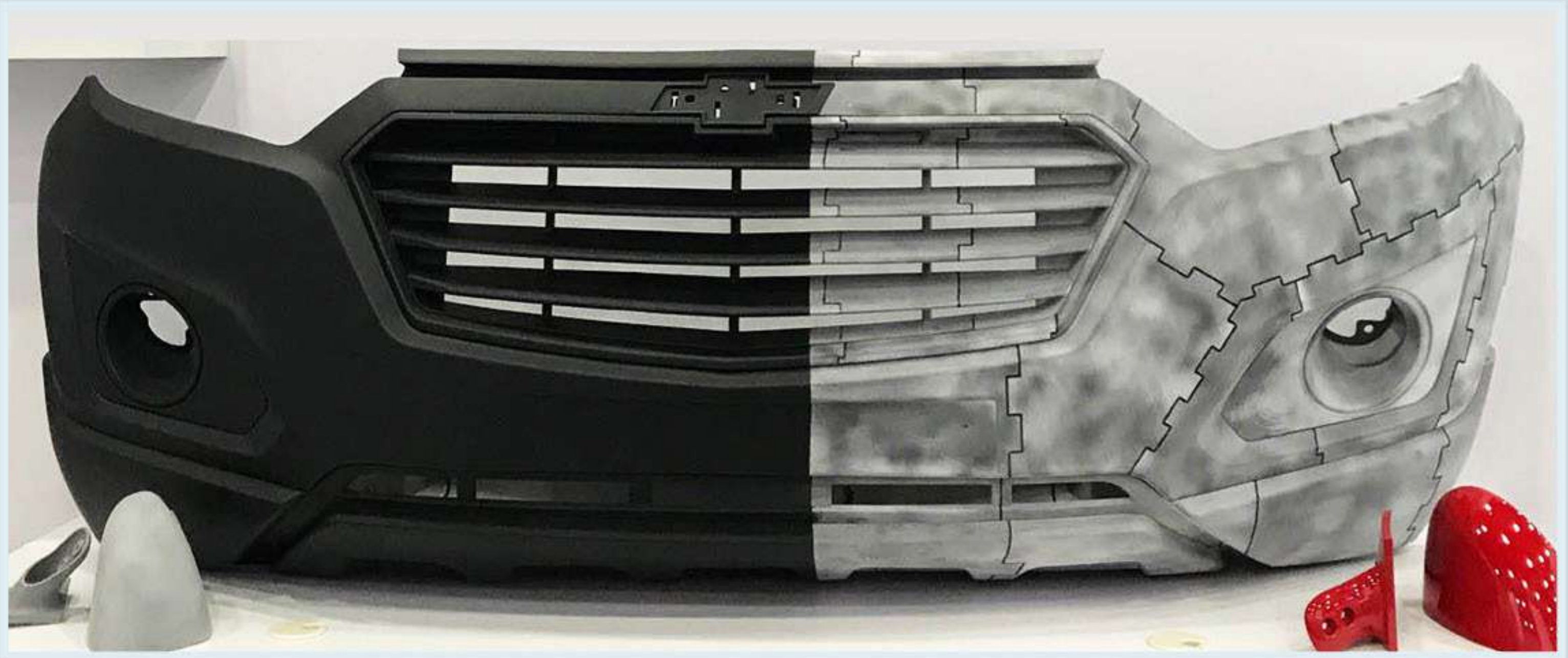

Automotive industry



Functional prototyping



Injection mold



Fixture



Prototyping and design



Portrait



Medical Industry

Product Parameters

Model : MD-600D

Print Technology : Fused Deposition Modeling(FDM)

Print Volume : 600*600*600 mm

Machine Dimensions : 1300*965*1255 mm

Extruder Type: : Dual Extruders

Nozzle Diameter: : 0.4mm (0.6, 0.8, 1.0 mm optional)

Extruder Temperature : $\leq 350^{\circ}\text{C}$

Platform Temperature : $\leq 110^{\circ}\text{C}$

Max Flow : $40\text{mm}^3/\text{s}$

Max Print Speed : 500mm/s
(Recommend Printing Speed: 200-300mm/s)

Support Software : MingDa OrcaSlicer, Prusa Slicer, etc

Filament Compatibility :
Common filament: PLA, TPU, PETG;
Engineering filament: PA-CF/GF, PET-CF/GF, HtPA-CF/GF, ABS-GF25, ABS-CF20, PA-GF25/CF25;
Support filament: S-Mulit, S-HtPA, PVA, etc

Display Screen : 7-inch HDMI touch screen

Input Voltage : 100/240AC 50/60Hz

Rated Power : 1400W (Hot Bed Power: 1200W)

Firmware : klipper